

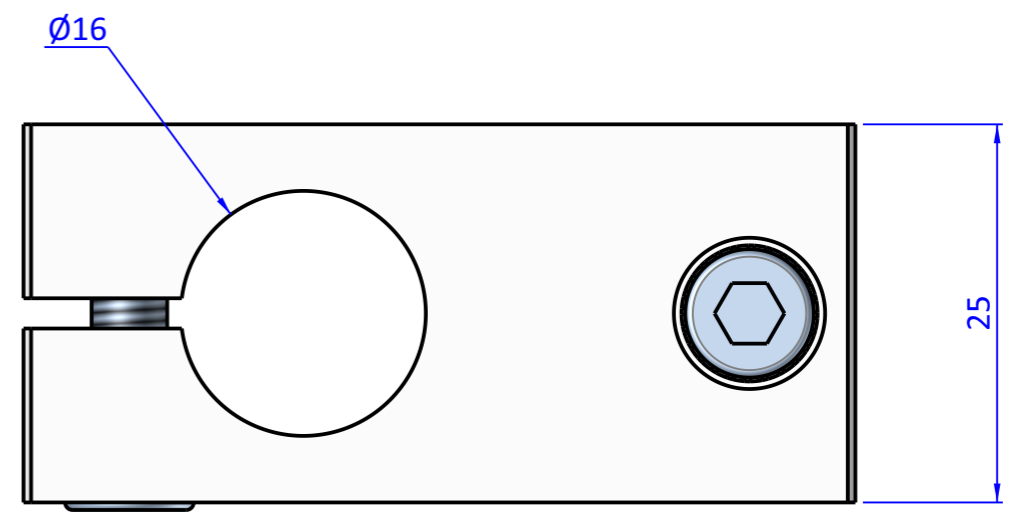

THE PROPERTY OF THE DRAWING IS ESTABLISHED BY LAW. IT IS FORBIDDEN TO PRODUCE OR SHOW IT TO THIRD PART, WITHOUT A WRITTEN AGREEMENT.

Item	Name	Q.ty
1	03.03.001	1
2	R.5.SCH	2
3	V.TCE5x16	2

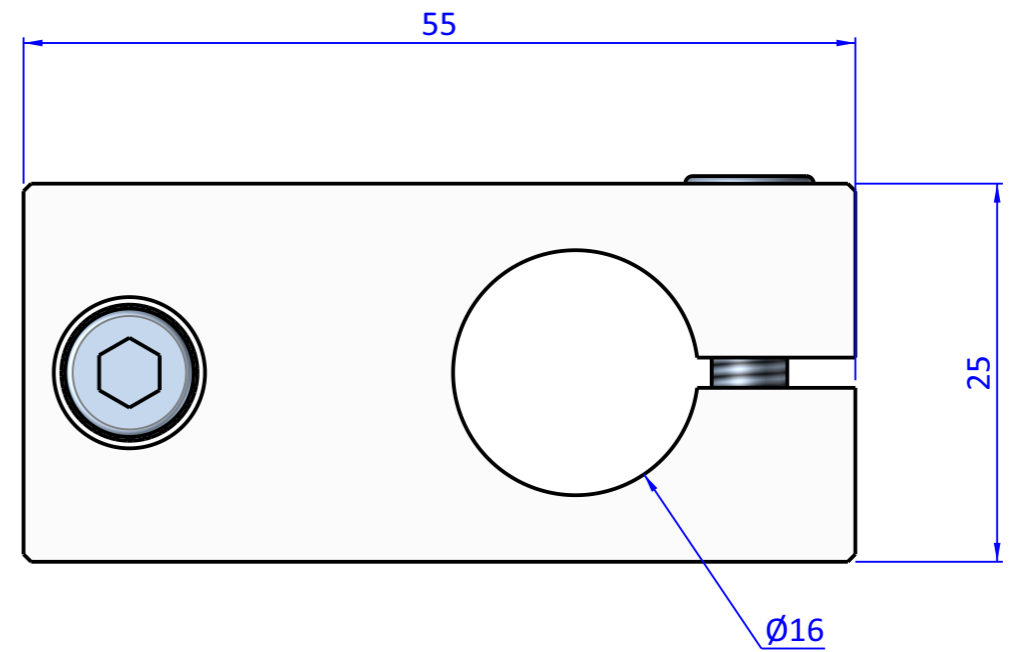
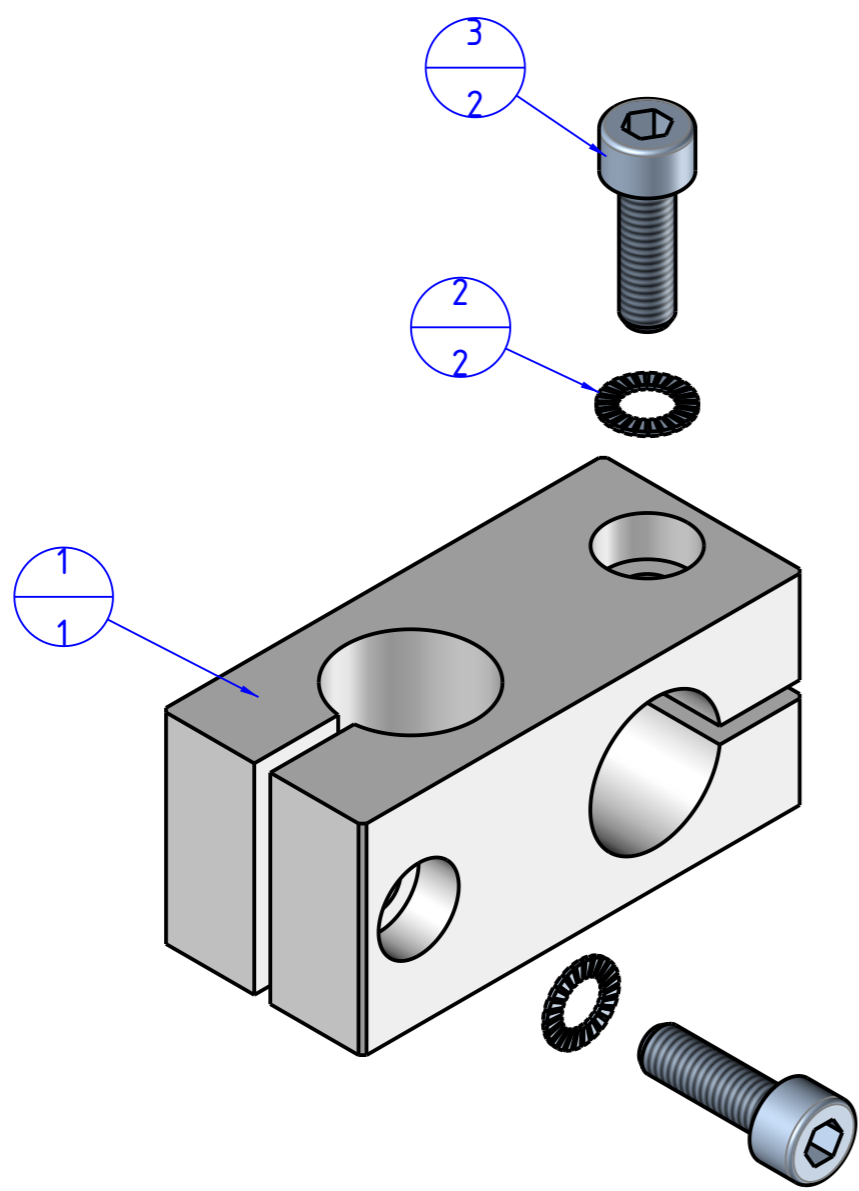

Format A3
UNI 936-76

 FPS SERVICES AUTOMATION		DESIGNED FROM FPS Automation		REVIEW A
		DATE 13/12/2023	WEIGHT 0,067kg	
GENERAL TOLERANCE UNI - ISO 2768 CLASSE f	DESCRIPTION CA.03.03.001	CODE CA.03.03.001		